

080.9745.04

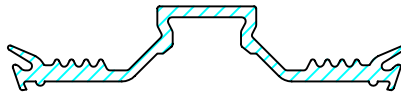

034.0551.XX vorgelocht

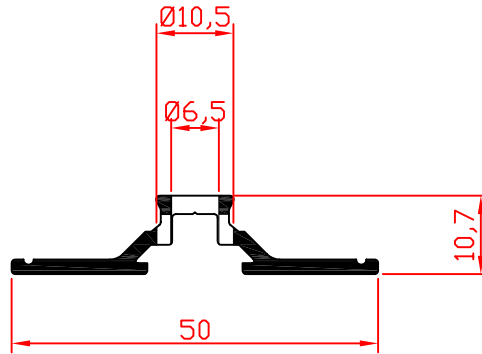

080.9746.04

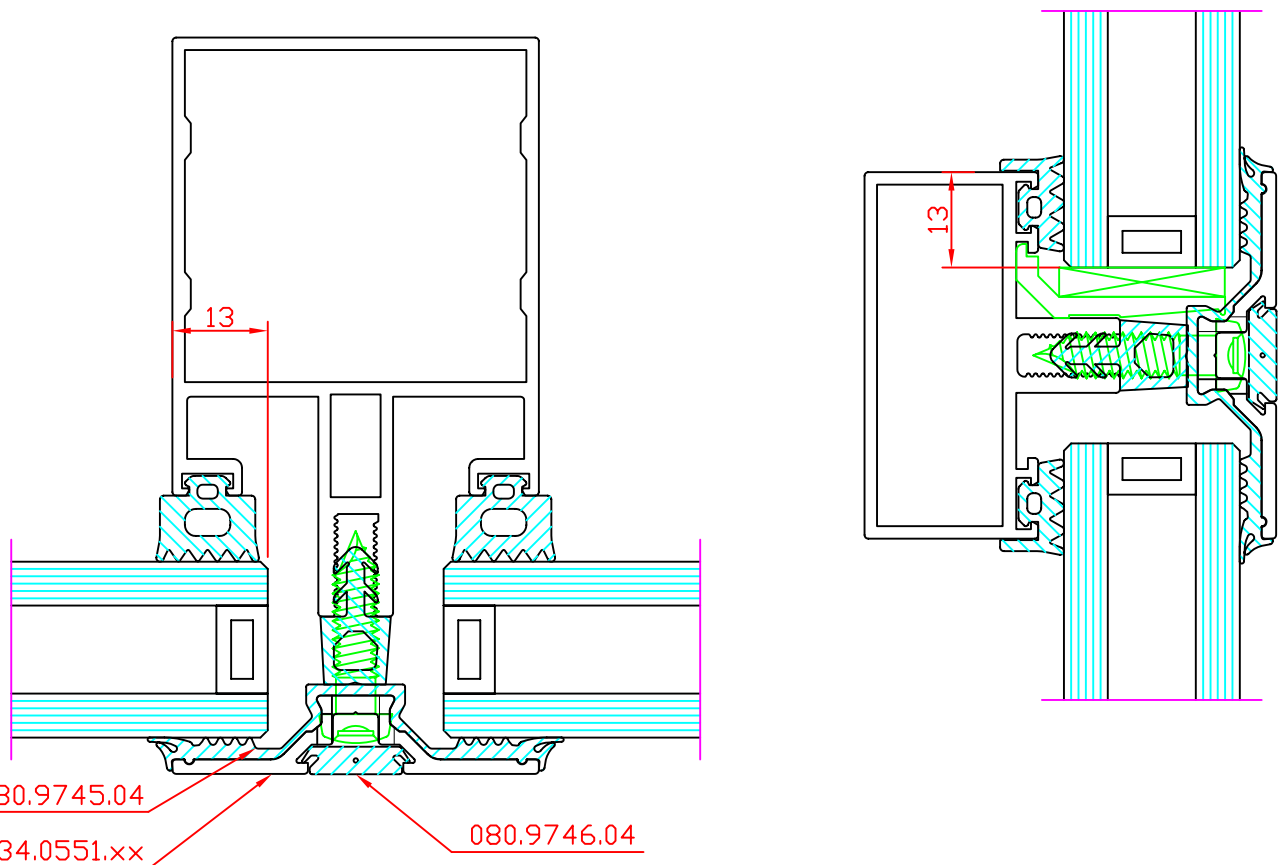
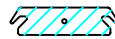

This drawing is our property. Each duplication, utilization or passing on to third persons is forbidden and will be pursued.

-	Blatt erstellt	18.02.08	Tia
Index	Bearbeitung	Datum	Name



NEWS
01/2008

Bezeichnung
neue CW 50 Andruckleiste
voraussichtlich verfügbar
ab Woche 13/2008

Größe:
DIN A4
Blatt
012
Index -

This drawing is our property. Each duplication, utilization or passing on to third persons is forbidden and will be pursued.

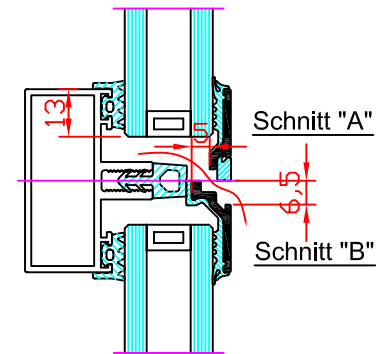
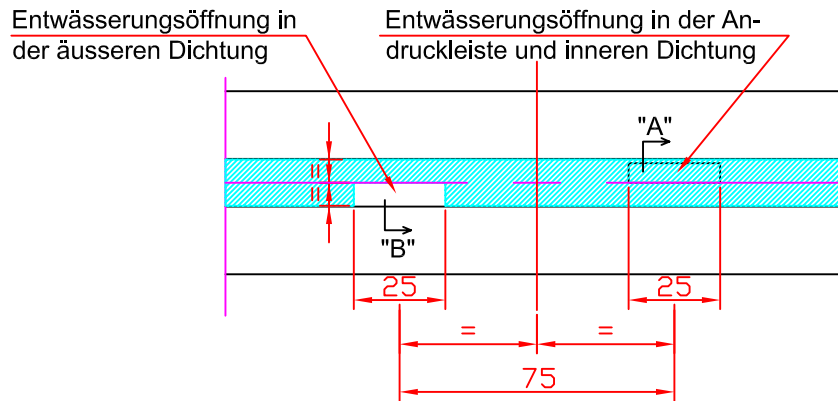
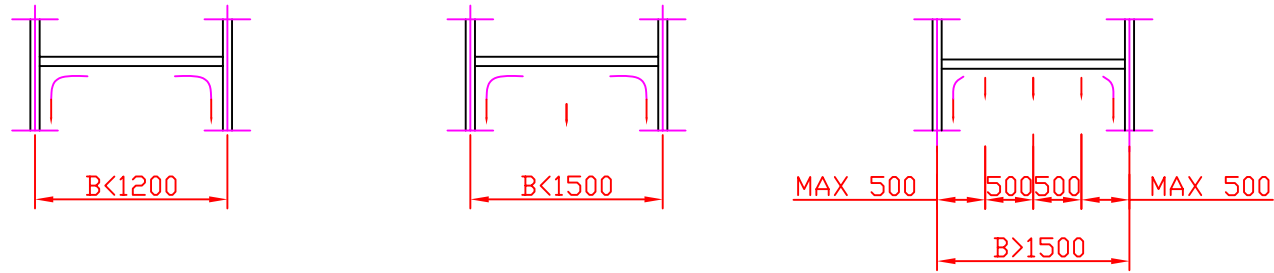

-	Blatt erstellt	18.02.08	Tia
Index	Bearbeitung	Datum	Name



NEWS
01/2008

Bezeichnung

neue CW 50 Andruckleiste
Entwässerungsprinzip

Größe:
DIN A4

Blatt
013

Index
-