











<b>A</b>  080.9429.04 + 034.0514.XX   080.9429.04 + 034.0514.XX	<b>B</b> 034.1060.XX + <b>C</b> 080.9741.04 <b>D</b> 24mm <b>E</b> 080.9008.04 + <b>F</b> 007.0805.01	<b>G</b>  080.9429.04 + 034.0514.XX   080.9328.04 + 034.0618.XX
	<b>B</b> 034.1060.XX + <b>C</b> 080.9740.04 <b>D</b> 26 --> 30mm <b>E</b> 080.9008.04 + <b>F</b> 007.0805.01	
	<b>B</b> 034.1060.XX + <b>C</b> 080.9742.04 <b>D</b> 32mm <b>E</b> 080.9008.04 + <b>F</b> 007.0805.01	

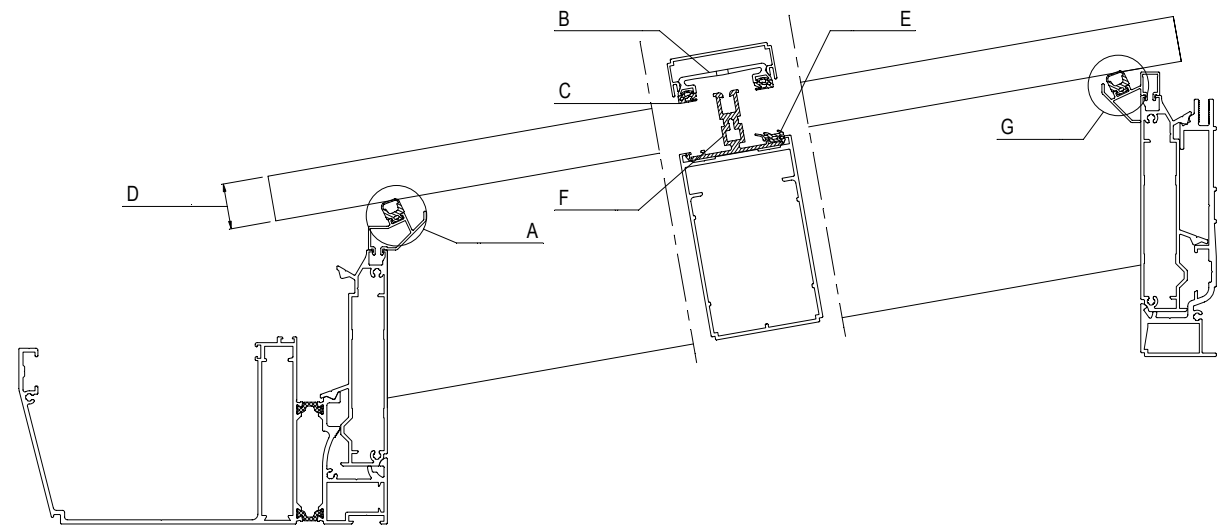
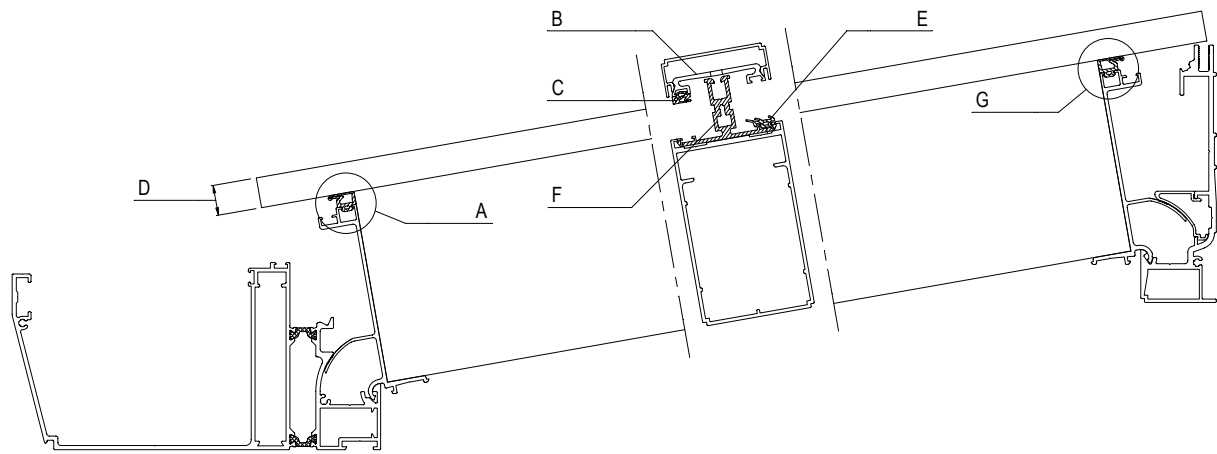
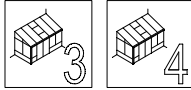

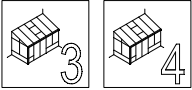
<b>A</b>  080.9328.04 + 034.0618.XX   080.9328.04 + 034.0618.XX	<b>B</b> 034.1060.XX + <b>C</b> 080.9741.04 <b>D</b> 24mm <b>E</b> 080.9008.04 + <b>F</b> 007.0805.01	<b>G</b>  080.9328.04 + 034.0618.XX   080.9328.04 + 034.0618.XX
	<b>B</b> 034.1060.XX + <b>C</b> 080.9740.04 <b>D</b> 26 --> 30mm <b>E</b> 080.9008.04 + <b>F</b> 007.0805.01	
	<b>B</b> 034.1060.XX + <b>C</b> 080.9742.04 <b>D</b> 32mm <b>E</b> 080.9008.04 + <b>F</b> 007.0805.01	

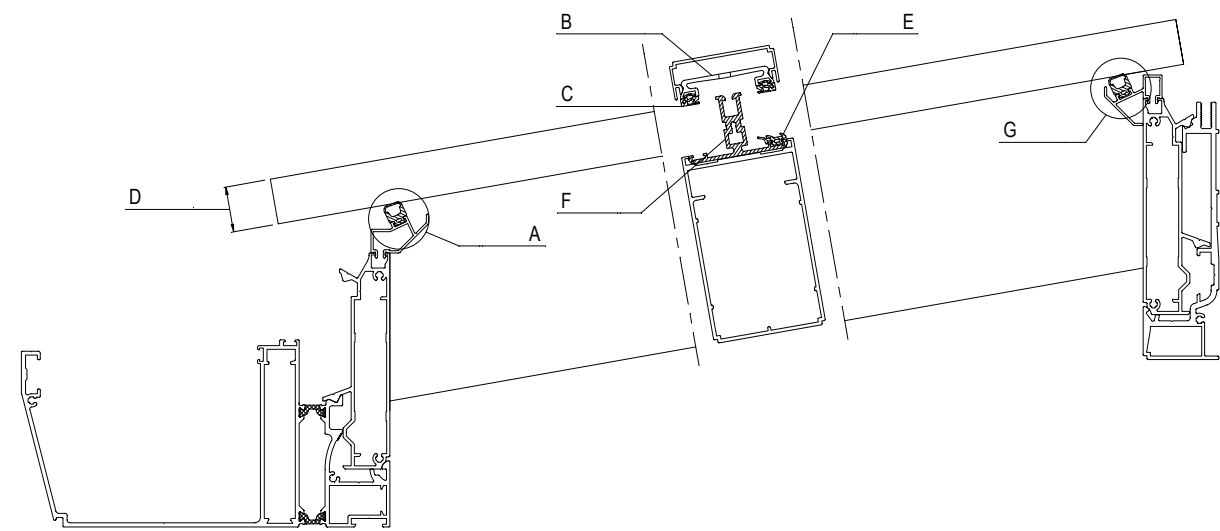
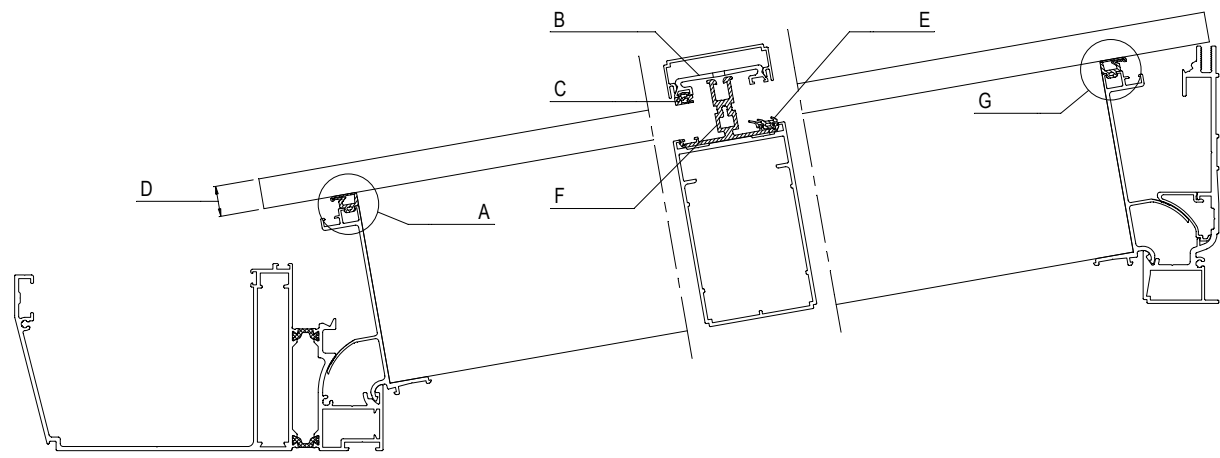

D007744

<p><b>A</b></p>  <p>080.9426.SY + 034.0514.XX</p>	<p>B 034.1060.XX + C 080.9741.04</p>	<p><b>G</b></p>  <p>080.9426.SY + 034.0514.XX</p>
	<p>D 24mm E 080.9008.04 + F 007.0805.01</p>	
	<p>B 034.1060.XX + C 080.9740.04</p>	
	<p>D 26 --&gt; 30mm E 080.9008.04 + F 007.0805.01</p>	
	<p>B 034.1060.XX + C 080.9742.04</p>	
	<p>D 32mm E 080.9008.04 + F 007.0805.01</p>	

D007744