













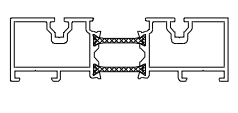

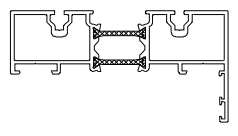

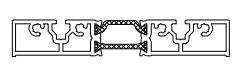





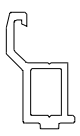

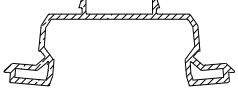

BUITENKADER
DORMANT
OUTER FRAME
BLENDRAHMEN

			$I_x \text{ cm}^4$	$W_x \text{ cm}^3$	ax mm	$I_y \text{ cm}^4$	$W_y \text{ cm}^3$	ay mm	
006.1506.XX		5.50/7.00	51.141	10.654	48.00	3.478	2.322	14.98	
006.1514.XX		7.00	59.384	11.587	44.75	5.523	1.617	34.16	
006.0517.XX		7.00	33.062	6.888	48.00	1.470	1.722	8.54	

OPZETPROFIEL
PROFILE AUXILIAIRE
AUXILIARY PROFILE
ZUSATZPROFIL

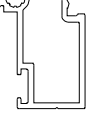
			$I_x \text{ cm}^4$	$W_x \text{ cm}^3$	ax mm	$I_y \text{ cm}^4$	$W_y \text{ cm}^3$	ay mm	
006.0502.XX		7.00	0.103	0.144	7.14	0.297	0.231	9.17	
006.0503.04		7.00	-	-	-	-	-	-	

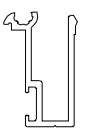

VERBORGEN ONTWERING
DRAINAGE CACHE
HIDDEN DRAINAGE
VERDECKTER ENTWAESSERUNG

			$I_x \text{ cm}^4$	$W_x \text{ cm}^3$	ax mm	$I_y \text{ cm}^4$	$W_y \text{ cm}^3$	ay mm	
006.0570.XX		7.00	0.382	0.335	8.38	0.689	0.505	11.66	
006.0571.XX		7.00	0.194	0.203	6.68	0.597	0.448	11.96	

CP 96-LS

BUITENKADER
DORMANT
BLENDRAHMEN
OUTER FRAME



	$\frac{A}{dm^2/m}$	$\frac{P}{dm^2/m}$	L_m	$I_x \text{ cm}^4$	$W_x \text{ cm}^3$	ax mm	$I_y \text{ cm}^4$	$W_y \text{ cm}^3$	ay mm	
006.0517.XX	24.11	9.9	7.00	33.062	6.888	48.00	1.470	1.722	8.54	X Y X 0

006.0517.XX

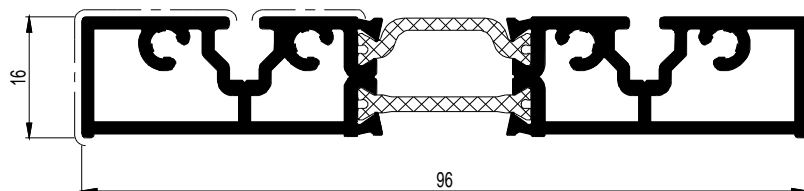

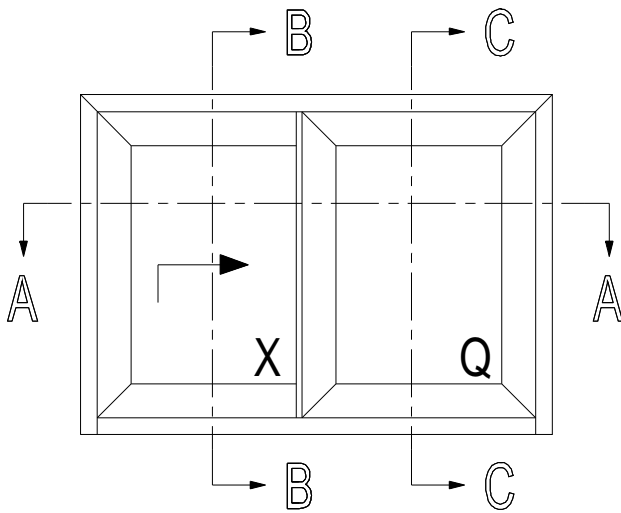

		#	
062.6799.--		1	38.G...
062.7957.ZC		1	38.G...
062.7958.ZC		1	38.G...
062.6922.XX		1	38.G...
062.6923.XX		1	38.G...
061.7043.--		1	38.G...
052.5336.--		1	38.G...
052.5335.--		5	38.G...
052.5338.--		8	38.G...

150kg

A - A

B

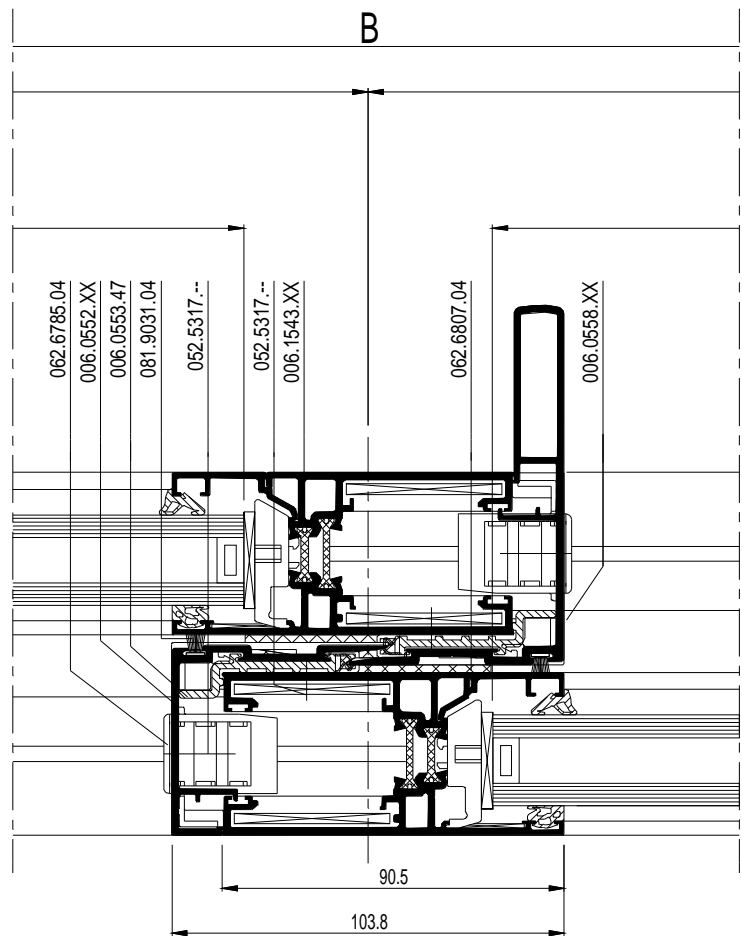
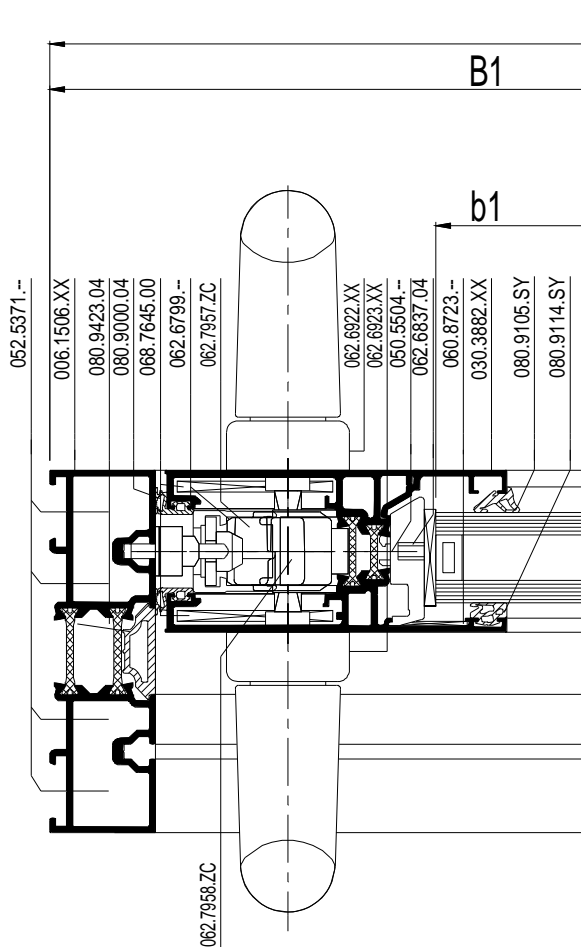

D0069680

		#	
062.6800.--		2	38.G...
062.7902.ZC		1	38.G...
062.7862.XX		1	38.G...
062.7863.XX		1	38.G...
061.7043.--		1	38.G...
050.5504.--		1	38.G...

300kg

b1=B1-135
b2=B2-135
h=H-202.5

			#	L_m	
006.0517.XX			1	B - 56	38.C...
006.1506.XX			1	B	38.C...
			2	H	
011.4631.--			1	B - 43	38.C...
006.1543.XX			4	H-59.5	38.C...
			2	B1+8	
			2	B2+8	
006.0552.XX			1	H-100.5 (a) (062.6785.04) OF-OU-OR-ODER	38.C...
			1	H-60.5 (b) (062.6806.04)	
006.0558.XX			1	H-100.5 (a) (062.6785.04) OF-OU-OR-ODER	38.C...
			1	H-60.5 (b) (062.6806.04)	
030.3882.XX			4	H-240.5	38.C...
			2	B1-123	
			2	B2-123	
006.0553.47			2	H-60.5	38.C...
006.0502.XX			2	B-56	38.C...
006.0503.04			1	B-56	38.C...
0M0.1505.XX			1	B1-658.4	38.F...
			1	B2-658.4	

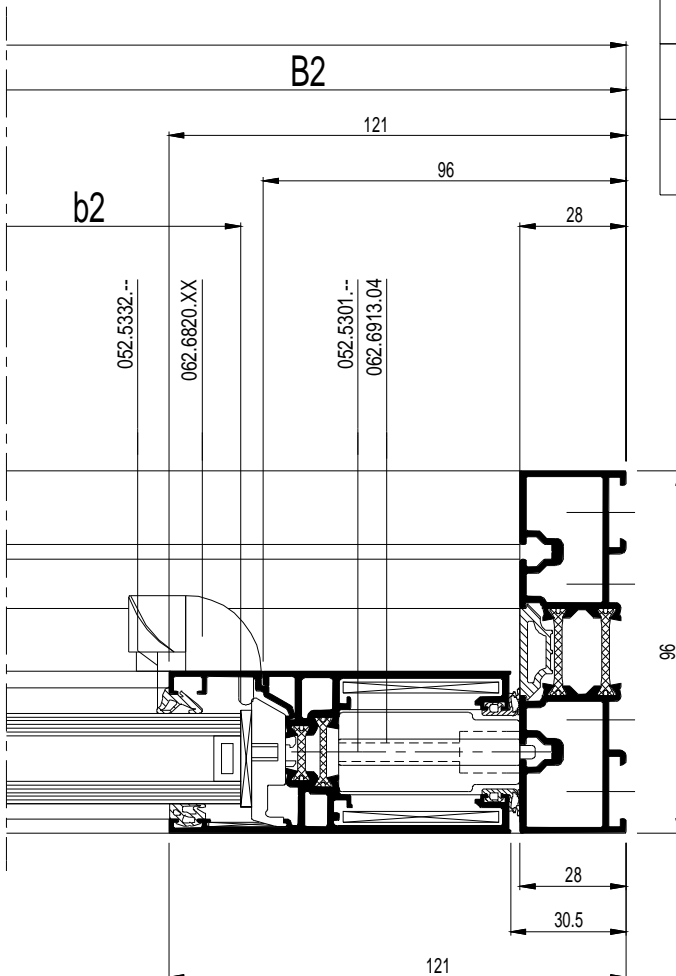

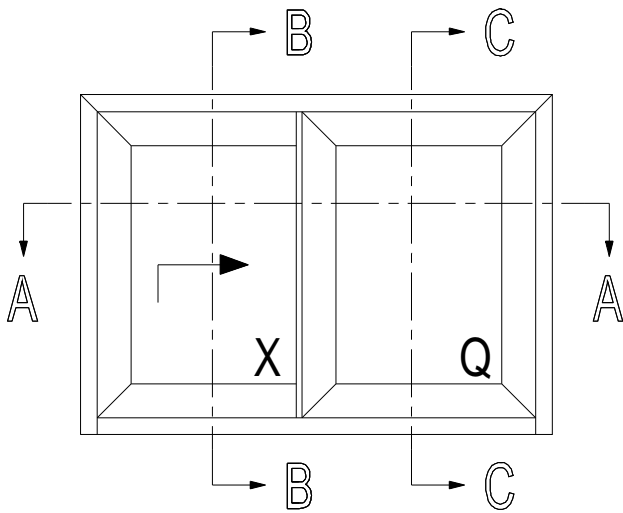

B - B

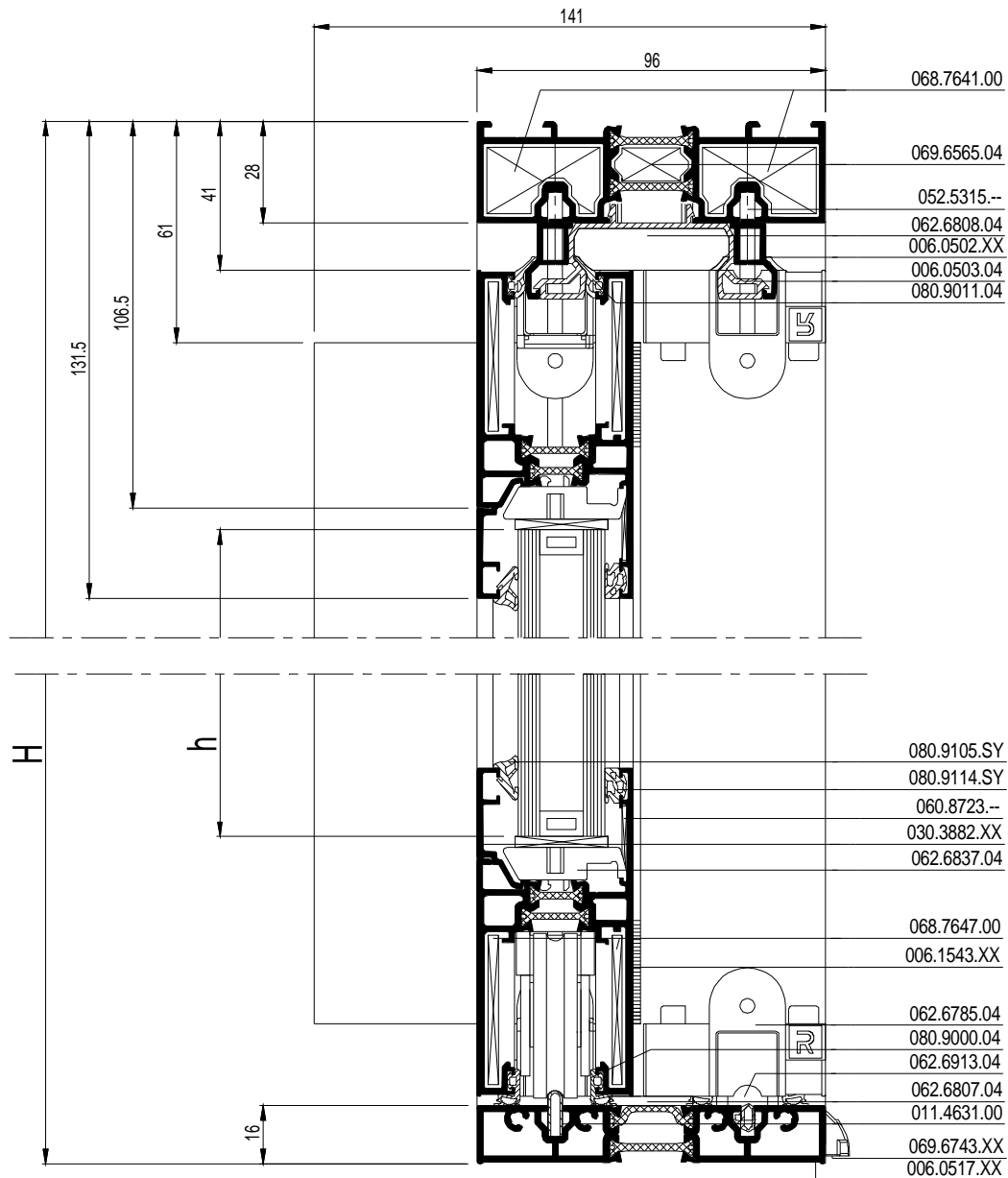

D0069681

			#	
	068.7641.00		2	38.G....
	068.7647.00		8	38.G....
	069.6565.04		2	38.G....
	060.8723.--		8	38.G....
(a)	062.6785.04		2	38.G....
(b)	062.6806.04		2	38.G....
	052.5317.--		4	38.G....
	071.6554.04		4	38.G....
	062.6913.04		4	38.G....
	052.5301.--		4	38.G....
	052.5305.--		4	38.G....

			#	
	062.6837.04		18	38.G....
	062.6820.XX		1	38.G....
	052.5332.--		1	38.G....
	069.6747.04		38.F....	38.G....
	080.9423.04		Hx2	38.G....
	080.9000.04		Hx4+B1x2+B2x2	38.G....
	080.9011.04		B1x2+B2x2	38.G....
	062.6807.04		1	38.G....
	062.6808.04		1	38.G....
	080.9430.--		Bx1	38.G....
	062.9510.04		1	38.G....
	080.9105.SY		hx4+b1x2+b2x2	38.G....
	080.9114.SY		hx4+b1x2+b2x2	38.G....
	052.5315.--		1/300mm	38.G....
	052.5317.--		38.F....	38.G....
	052.5371.--		8	38.G....
	081.9031.07		H x 2	38.G....
	069.6743.XX		min. 2	38.G....

C - C

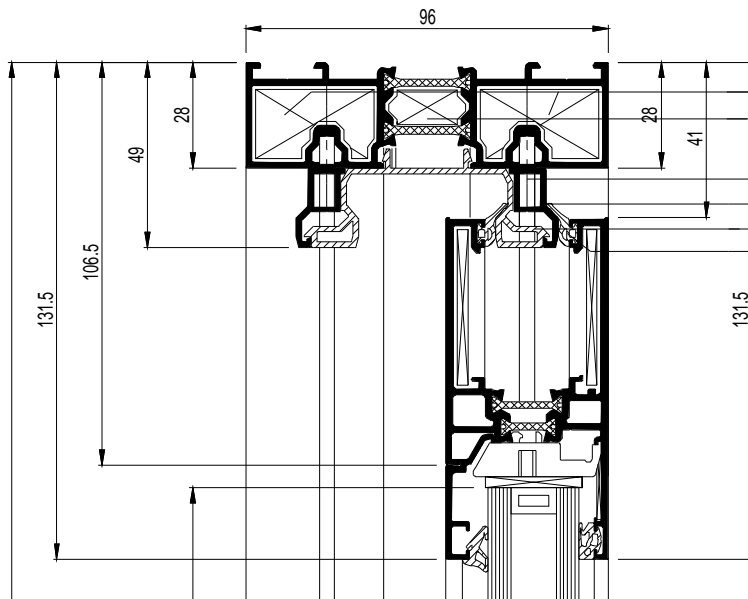

- 068.7641.00
- 069.6565.04
- 052.5315.--
- 006.0502.XX
- 006.0503.04
- 080.9011.04

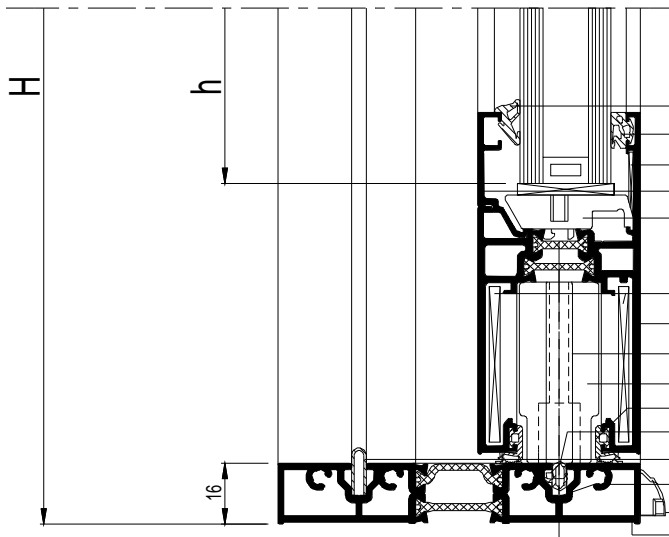

- 080.9105.SY
- 080.9114.SY
- 060.8723.--
- 030.3882.XX
- 062.6837.04
- 068.7647.00
- 006.1543.XX
- 052.5301.--
- 062.6913.04
- 080.9000.04
- 080.9430.04
- 011.4631.--
- 052.5305.--
- 069.6743.XX
- 006.0517.XX

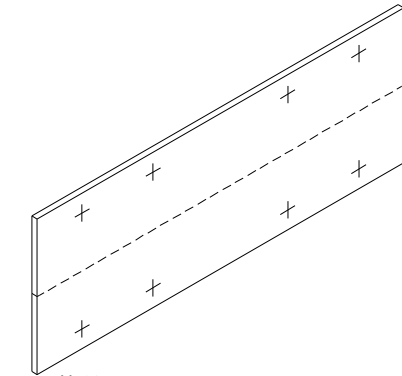

H=36
B=2
D=98

062.9510.04

AFDICHTING BUITENKADER

FERMETURE DORMANT

CLOSER OUTER FRAME

ABDICHTUNG BLENDRAHMEN

CP 96-LS